

TRANSFORMERS

DARK OF THE MOON™

AGES 5+

32117/32114 ASST.

AUTOBOT

BUMBLEBEE™

INTERMEDIATE

LEVEL: 1 2 3

NOTE: Some parts are made to detach if excessive force is applied, and are designed to be reattached if separation occurs. Adult supervision may be necessary for younger children.



CHANGING TO ROBOT

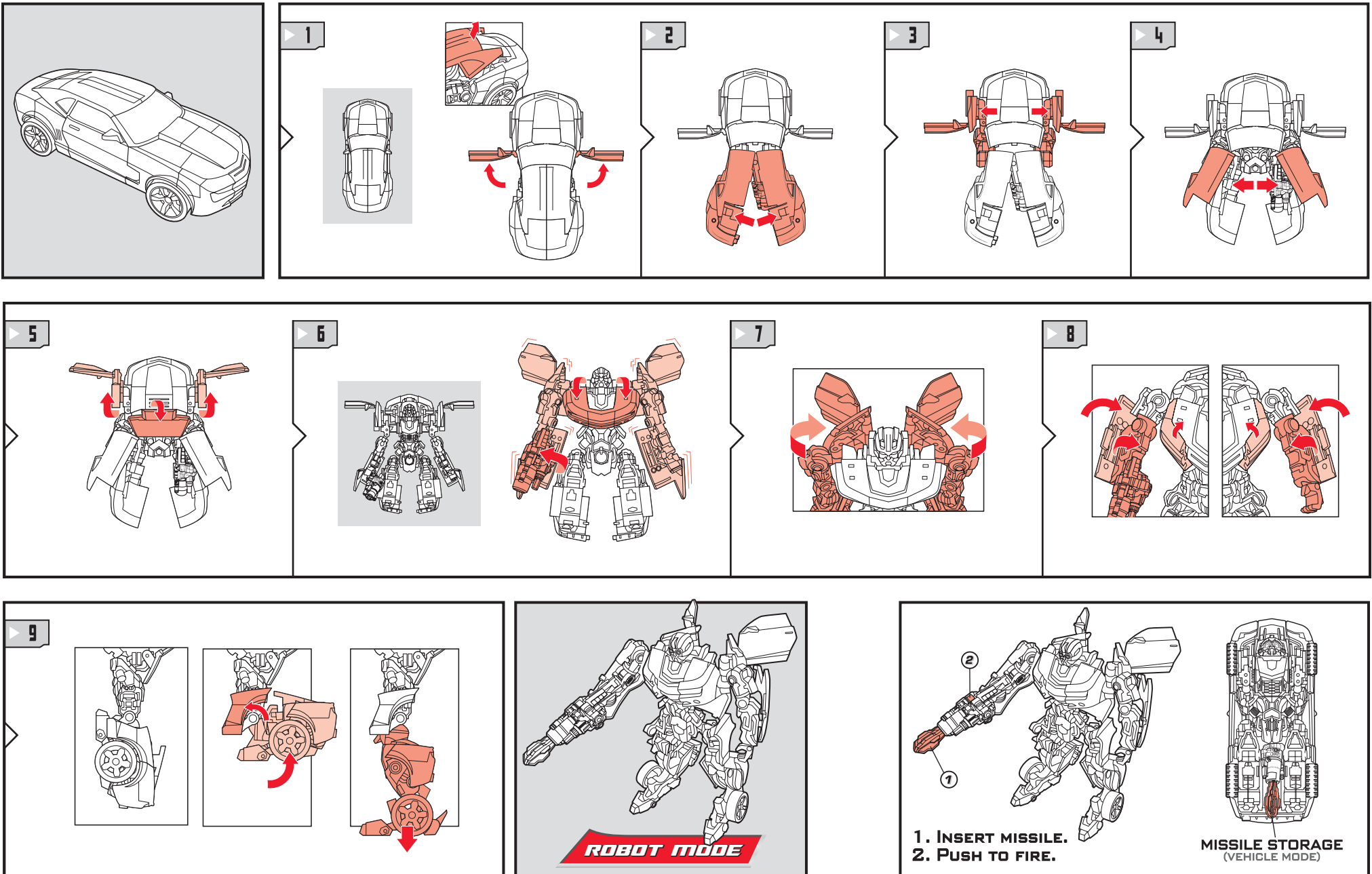

CHANGING TO VEHICLE

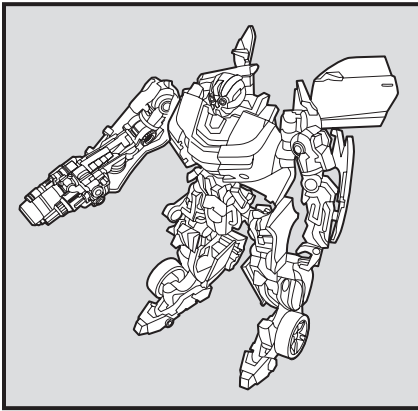

▶ 1

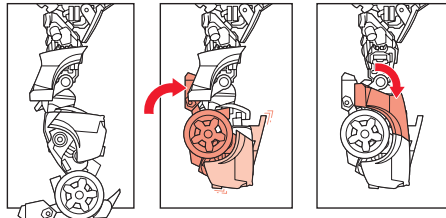

▶ 2

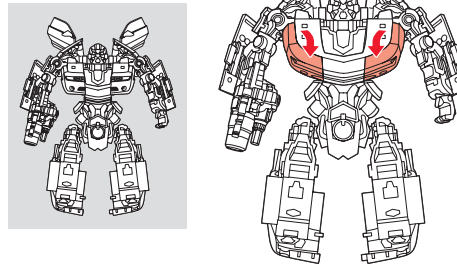

▶ 3

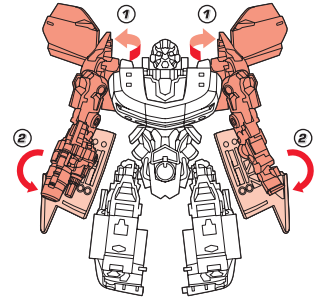

▶ 4

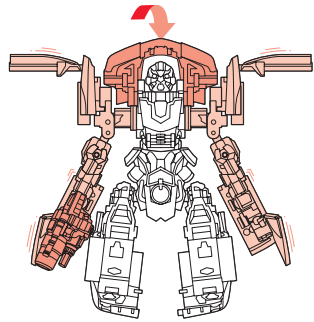

▶ 5

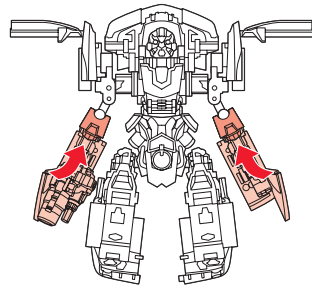

▶ 6

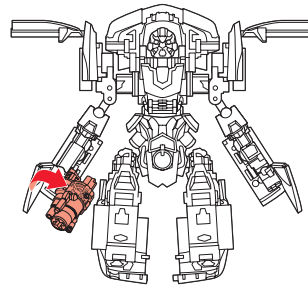

▶ 7

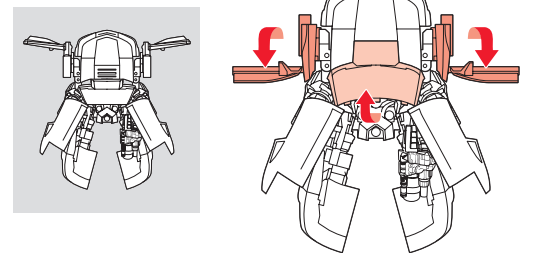

▶ 8

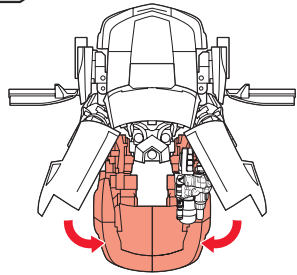

▶ 9

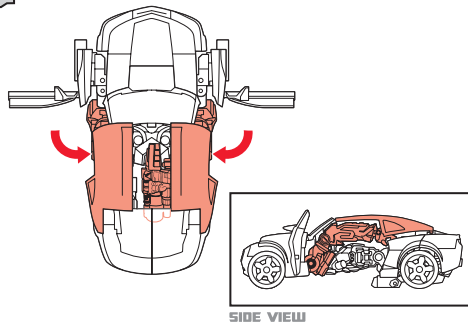

▶ 10

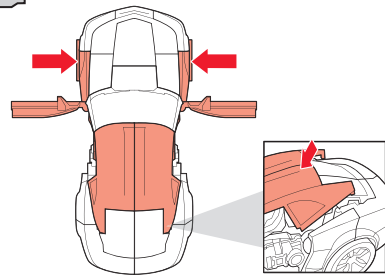

▶ 11

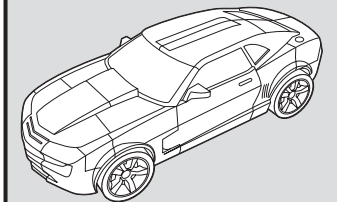
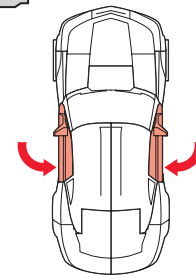

VEHICLE MODE

Retain instructions for future reference.

Product and colors may vary. Some poses may require hand support.
 © 2011 Paramount Pictures Corporation.
 Manufactured under license from TOMY Company, Ltd.
 ®* and/or TM* & © 2011 Hasbro. All Rights Reserved. TM & © denote U.S. Trademarks.



Camaro and all related Emblems and body designs are General Motors Trademarks used under license to Hasbro, Inc.

P/N 717397000

TRANSFORMERS.COM/INSTRUCTIONS